



STAGE V
CERTIFIED

SFC
HANGCHA

XF SERIES

DIESEL COUNTERBALANCED TRUCKS

with capacities of 8,000 to 12,000kg

HANGCHA GROUP CO., LTD.

Factory site: 666 Xiangfu Road,
Hangzhou, Zhejiang, China (311305)

Tel: +86-571-88926735 88926755
Fax: +86-571-88926789 88132890

sales@hcforklift.com www.hcforklift.com

HANGCHA GROUP CO., LTD. reserves the right to make any changes without notice concerning colors, equipment, or specifications detailed in this brochure, or to discontinue individual models. The colors of trucks, delivered may differ slightly from those in brochures.



Follow us on Facebook



Follow us on YouTube



Follow us on WeChat



Download "Hangcha Forklift" App



ISO45001:2018



ISO14001:2015



ISO9001:2015



HANGCHA trucks conform to the European Safety Requirements.

COMFORTABLE OPERATION

Comfortable also contribute to increased productivity.



▶ Only 90N parking brake force is required.



▶ The new automobile-style light/turn-signal lever and forward-reverse lever are ergonomically designed and arranged to improve comfort and productivity.



▶ The new, relocated easy-to-see LCD meter lets the operator check on all aspects of operational status at a glance.



▶ The automobile-style suspended pedals provide more ergonomic operation.

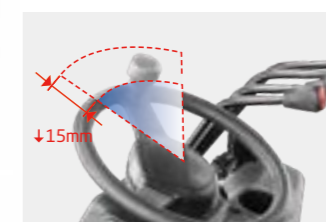

▶ The small diameter steering wheel with tilt adjustment provides the ideal operating position. The superior responsiveness of the steering wheel optimizes maneuverability even in narrow spaces.



STAGE V

HANGCHA be with you at every stage

Efficient, reliable solutions for your demands

▶ With Hangcha you can meet all Stage V emissions standards which provides customer demands for value, innovation and performance. The technologies include ,TCI+CR+EGR+DOC+DPF+SCR. Designed and optimised to every engine model, our forklift truck maximises efficiency and reliability.

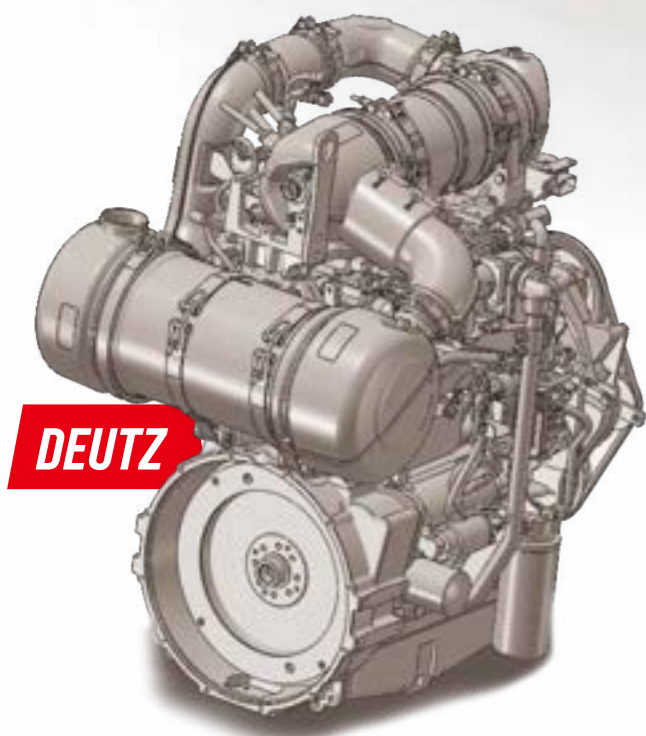

DEUTZ

HANGCHA FORKLIFT WITH STAGE V

No.	Capacity	Series	Manufacturer	Engine	Drive power	Model	Emission Std.	Transmission	Power (kw/rpm)	Service brake
1	8-10t	XF	DEUTZ	TCD3.6 L4	Diesel	CPCD80/100-XW96G	Stage V/T4f	ZF	85/2200	Wet brake
2	12t	XF	DEUTZ	TCD3.6 L4	Diesel	CPCD120-XXW96	Stage V/T4f	TCM	85/2200	Wet brake
3	8-10t	XF	Cummins	F3.8	Diesel	CPCD80/100-XH16B	Stage V/T4f	Okamura	90/2200	Wet brake
4	8-10t	XF	Yuchai	YCA05115-S500	Diesel	CPCD80/100-XH15B	Stage V	Okamura	85/2200	Wet brake
5	12t	XF	Cummins	F3.8	Diesel	CPCD120-XXH16	Stage V/T4f	Okamura	90/2200	Wet brake
6	12t	XF	Yuchai	YCA05115-S500	Diesel	CPCD120-XXH15	Stage V	Okamura	85/2200	Wet brake

Note: Stage V applied for European Union also including Israel and Turkey

In developing the new XF 8-12t series, comfort and easy operation is always considered, for example, improved vibrating levels, compound engine damper and full floating seat and cabin are applied.



▶ The extra foot space is provided to reduce operator fatigue significantly. The new wide-open, non-slip step makes getting in and out easy and safe.

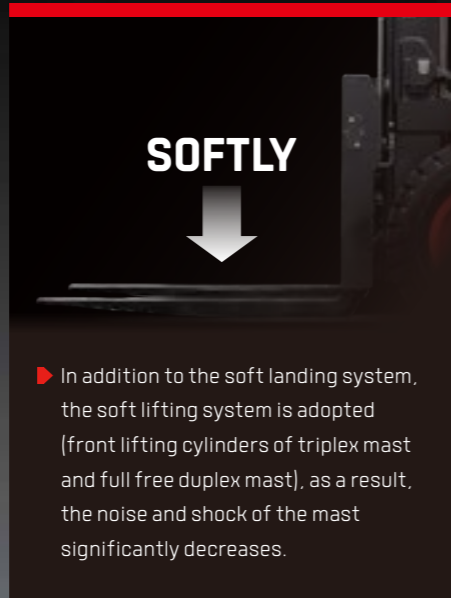

▶ In addition to the soft landing system, the soft lifting system is adopted (front lifting cylinders of triplex mast and full free duplex mast), as a result, the noise and shock of the mast significantly decreases.

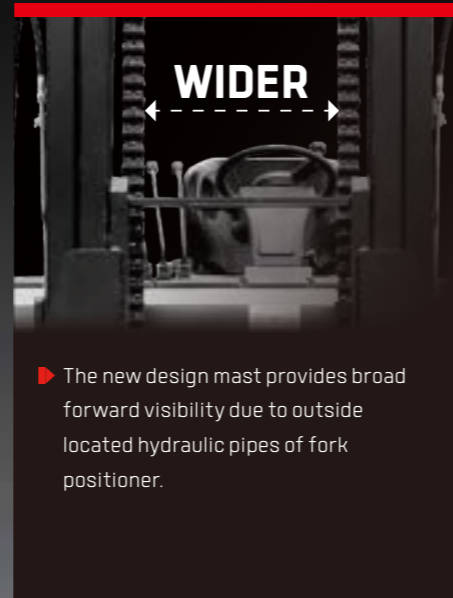

▶ The new design mast provides broad forward visibility due to outside located hydraulic pipes of fork positioner.

▶ The optional Electro-hydraulic proportional control system contributes more sensitive and precise load handling. The easy-to-operate levers provide total load handling operation. An armrest is provided to reduce fatigue.



ENVIRONMENTAL FRIENDLINESS

Environmentally friendly material, low exhaust emission, and low noise level, all these are considered at the beginning of the product development.



▶ Special developed engine is applied for optimum balance of power and superior environmental performance. All diesel engines are in compliance with EU stage-III control regulation. The environment friendly materials, such as non-asbestos brake shoe and new type sealing gasket, are adopted entirely to meet environmental safety.



▶ The applied optimized exhaust muffler, intake muffler and the noise shield technologies are reduced 3dB at the driver's ear noise level.



PRODUCTIVITY

Thanks to the series technological innovations, the efficiency of the truck is improved, the energy consumption is reduced.

By optimizing transmission design, the power train provides higher efficiency, and the Max. driving speed is increased **20%**



The new efficiency LED lighting system and new type reflector reduce energy consumption, improve illumination performance and prolong working life.



The new patent dynamic load sensing hydraulic steering system contributes to reduce loss of hydraulic, improve energy consumption and increase 15% lifting speed.

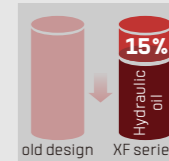

Interactive instrument: The instrument adopts LCD display with four interactive buttons, and has one CAN bus communication function. The communication protocol is compatible with CANopen and SAE J1939 standards.



RELIABILITY

By focusing on enhancing reliability, reducing downtime, the XF series is able to make the greater productivity for customer.



▶ The patent plated-fin type aluminum radiator is applied, the heat exchanging is approved, and improves the capability for operation in severe environments.

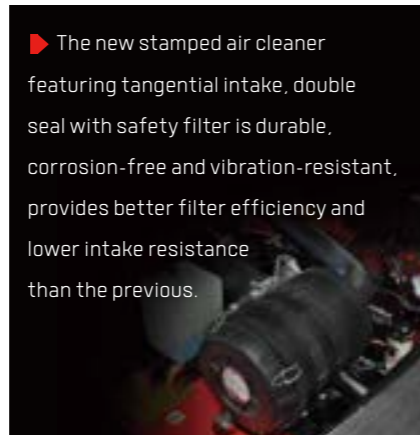

▶ The new stamped air cleaner featuring tangential intake, double seal with safety filter is durable, corrosion-free and vibration-resistant, provides better filter efficiency and lower intake resistance than the previous.

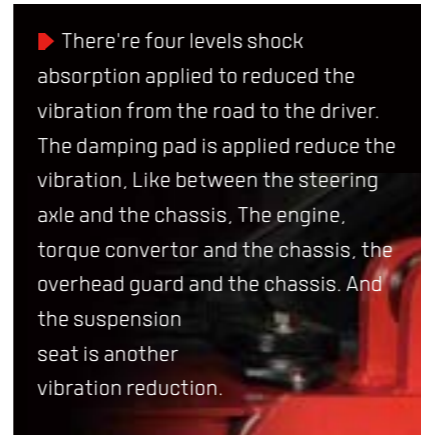

▶ There're four levels shock absorption applied to reduced the vibration from the road to the driver. The damping pad is applied reduce the vibration, Like between the steering axle and the chassis, The engine, torque converter and the chassis, the overhead guard and the chassis. And the suspension seat is another vibration reduction.



▶ All the controllers, relays, and safety fuses are allocated in the controller box, free to water and dust. The main electronic components are waterproof, which is capable operator in severe environment.

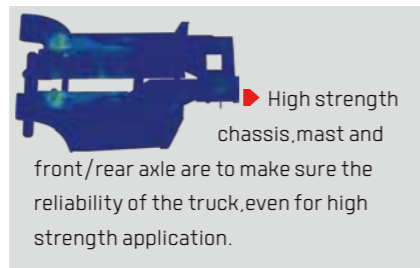

▶ High strength chassis, mast and front/rear axle are to make sure the reliability of the truck, even for high strength application.

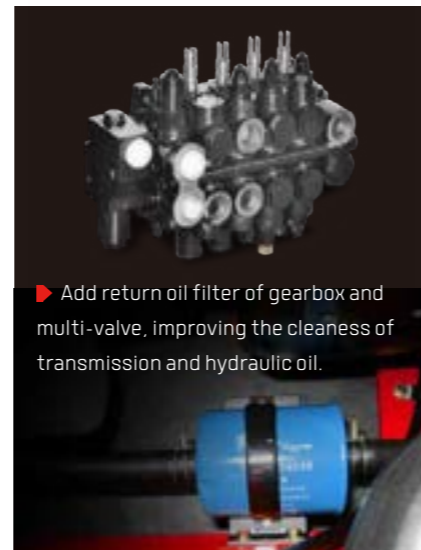

▶ Add return oil filter of gearbox and multi-valve, improving the cleanliness of transmission and hydraulic oil.



▶ The battery is located above the fuel tank, there's battery box and adiabatic plate between them to prolong the battery's working life.

EASY MAINTENANCE

Careful design facilitates inspection and servicing. Easy maintenance reduces the amount of downtime and helps to reduce cost also.

- ▶ The location of the air-filter is easy to reach, and it's very easy to replace the filter.
- ▶ All the locations of the engine oil level dipstick, filter of hydraulic, water separator are easy to reach, and very easy for engineer to check.
- ▶ Brake drum is installed outside of wheel hub, easy to remove and install when we replace the brake shoes.
- ▶ There's gas spring support for the front cover of radiator, and it can auto-open when the rear cover of radiator is opened.



SAFETY

A wide range of technologies are applied to ensure absolute safety for both the operator and those in the surrounding. Independent braking and steering circuit without interference.



- ▶ A throttling device is adopted to avoid the mast being out of control even some pipes are broken.



- ▶ There's an energy accumulator applied in the braking system, which means when the engine is shut down, it can also provides more than 4 times emergency brake.

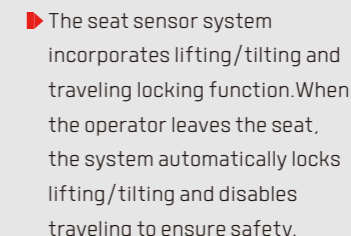

- ▶ The seat sensor system incorporates lifting/tilting and traveling locking function. When the operator leaves the seat, the system automatically locks lifting/tilting and disables traveling to ensure safety.

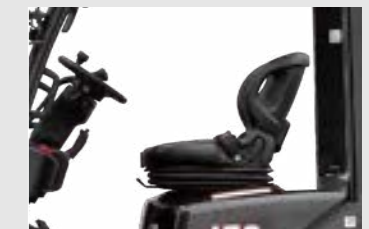

- ▶ The locking device of the engine hood damper and parking brake help add to safety.

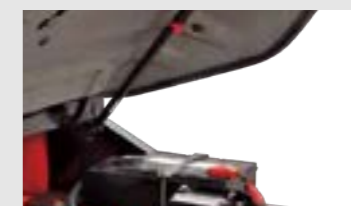

Technical data

		HANGCHA GROUP CO.,LTD.														
Distinguishing mark	1.1	Manufacturer														
	1.2	Manufacturer's type designation	CPCD80-XW41B	CPCD100-XW41B	CPCD120-XXW41	CPCD80-XW96G	CPCD100-XW96G	CPCD120-XXW96	CPCD80-XH16B	CPCD100-XH16B	CPCD120-XXH16	CPCD80-XH15B	CPCD100-XH15B	CPCD120-XXH15		
	1.3	Drive: electric (battery or mains), diesel, petrol, fuel gas	Diesel	Diesel	Diesel	Diesel	Diesel	Diesel	Diesel	Diesel	Diesel	Diesel	Diesel	Diesel		
	1.4	Operator type: hand, pedestrian, standing, seated, order-picker	Seat	Seat	Seat	Seat	Seat	Seat	Seat	Seat	Seat	Seat	Seat	Seat		
	1.5	Rated capacity/rated load	Q (kg)	8000	10000	12000	8000	10000	12000	8000	10000	12000	8000	10000	12000	
	1.6	Load centre distance	c(mm)	600	600	600	600	600	600	600	600	600	600	600	600	
	1.8	Load distance, centre of drive axle to fork	x(mm)	714	726	739	714	726	739	714	726	739	714	726	739	
	1.9	Wheelbase	y(mm)	2500	2800	2800	2600	2800	2800	2500	2800	2800	2500	2800	2800	
	2.1	Service weight	kg	11200	13000	14300	12000	13800	14800	12000	13800	14800	12000	13800	14800	
Weight	2.2	Axle loading, laden front/rear	kg	17280/1920	20940/2060	24100/2200	17980/2020	21515/2285	24520/2280	17980/2020	21515/2285	24520/2280	17980/2020	21515/2285	24520/2280	
	2.3	Axle loading, unladen front/rear	kg	4480/6720	6040/6960	6220/8080	4820/7180	6430/7370	6400/8400	4820/7180	6430/7370	6400/8400	4820/7180	6430/7370	6400/8400	
	3.1	Tyres: solid rubber, superelastic, pneumatic, polyurethane		pneumatic	pneumatic	pneumatic	pneumatic	pneumatic	pneumatic	pneumatic	pneumatic	pneumatic	pneumatic	pneumatic	pneumatic	
Tyres, chassis	3.2	Tyre size, front		9.00-20-14PR	9.00-20-14PR	9.00-20-14PR	9.00-20-14PR	9.00-20-14PR	9.00-20-14PR	9.00-20-14PR	9.00-20-14PR	9.00-20-14PR	9.00-20-14PR	9.00-20-14PR		
	3.3	Tyre size, rear		9.00-20-14PR	9.00-20-14PR	9.00-20-14PR	9.00-20-14PR	9.00-20-14PR	9.00-20-14PR	9.00-20-14PR	9.00-20-14PR	9.00-20-14PR	9.00-20-14PR	9.00-20-14PR		
	3.5	Wheels, number front rear (x - driven wheels)		4x/2	4x/2	4x/2	4x/2	4x/2	4x/2	4x/2	4x/2	4x/2	4x/2	4x/2		
	3.6	Tread, front	b10 (mm)	1628	1628	1628	1628	1628	1628	1628	1628	1628	1628	1628	1628	
	3.7	Tread, rear	b11 (mm)	1700	1700	1722	1700	1700	1722	1700	1700	1722	1700	1700	1722	
	4.1	Tilt of mast/fork carriage forward/backward	$\alpha/\beta(^{\circ})$	6/12	6/12	6/12	6/12	6/12	6/12	6/12	6/12	6/12	6/12	6/12	6/12	
	4.2	Height, mast lowered	h1 (mm)	2700	2850	3000	2700	2850	3000	2700	2850	3000	2700	2850	3000	
Dimensions	4.3	Free lift	h2 (mm)	200	200	200	200	200	200	200	200	200	200	200		
	4.4	Lift	h3 (mm)	3000	3000	3000	3000	3000	3000	3000	3000	3000	3000	3000		
	4.5	Height, mast extended	h4 (mm)	4215	4555	4705	4215	4555	4705	4215	4555	4705	4215	4555	4705	
	4.7	Height of overhead guard	h6 (mm)	2580	2580	2580	2580	2580	2580	2580	2580	2580	2580	2580	2580	
	4.8	Seat height	h7 (mm)	1505	1505	1505	1505	1505	1505	1505	1505	1505	1505	1505	1505	
	4.12	Coupling height	h10 (mm)	505	505	505	505	505	505	505	505	505	505	505	505	
	4.19	Overall length	l1 (mm)	5404	5736	5849	5504	5736	5849	5404	5736	5849	5404	5736	5849	
	4.20	Length to face of forks	l2 (mm)	3904	4236	4349	4004	4236	4349	3904	4236	4349	3904	4236	4349	
	4.21	Overall width	b1 (mm)	2165	2165	2165	2165	2165	2165	2165	2165	2165	2165	2165	2165	
	4.22	Fork dimensions	s/e/l (mm)	75x160x1520	80x160x1520	80x200x1520	75x160x1520	80x160x1520	80x200x1520	75x160x1520	80x160x1520	80x200x1520	75x160x1520	80x160x1520	80x200x1520	
	4.23	Fork carriage DIN 15173, class/type A, B		/	/	/	/	/	/	/	/	/	/	/	/	
	4.24	Fork-carriage width	b3 (mm)	2000	2000	2000	2000	2000	2000	2000	2000	2000	2000	2000	2000	
	4.31	Ground clearance, laden, mast	m1 (mm)	250	250	250	250	250	250	250	250	250	250	250	250	
	4.32	Ground clearance, centre of wheelbase	m2 (mm)	339	339	339	339	339	339	339	339	339	339	339	339	
	4.34.1	Aisle width for pallets 1000 x 1200 crossways	Ast (mm)	5544	5866	5979	5644	5866	5979	5544	5866	5979	5544	5866	5979	
	4.34.2	Aisle width for pallets 800 x 1200 lengthways	Ast (mm)	5744	6066	6179	5844	6066	6179	5744	6066	6179	5744	6066	6179	
	4.35	Turning radius	Wa (mm)	3630	3940	4040	3730	3940	4040	3630	3940	4040	3630	3940	4040	
4.36	Internal turning radius	b13 (mm)	1327	1396	1396	1350	1396	1396	1327	1396	1396	1327	1396	1396		
Performance data	5.1	Travel speed, laden/unladen	km/h	-/28.5	-/28.5	-/27	-/28.5	-/28.5	-/29	-/28.5	-/28.5	-/29	-/28.5	-/28.5	-/29	
	5.2	Lift speed, laden/unladen	m/s	0.440/-	0.330/-	0.360/-	0.390/-	0.317/-	0.330/-	0.440/-	0.330/-	0.330/-	0.440/-	0.330/-	0.330/-	
	5.3	Lowering speed, laden/unladen	m/s	0.455/-	0.455/-	0.455/-	0.455/-	0.455/-	0.455/-	0.455/-	0.455/-	0.455/-	0.455/-	0.455/-	0.455/-	
	5.5	Drawbar pull, laden/unladen	N	65000/45000	65000/49000	65000/49000	65000/45000	65000/49000	65000/49000	65000/45000	65000/49000	65000/49000	65000/45000	65000/49000	65000/49000	
	5.7	Gradeability, laden/unladen	%	>20/-	>20/-	>20/-	>20/-	>20/-	>20/-	>20/-	>20/-	>20/-	>20/-	>20/-	>20/-	
	5.10	Service brake		Drum brake	Drum brake	Wet brake	Wet brake	Wet brake	Wet brake	Wet brake	Wet brake	Wet brake	Wet brake	Wet brake	Wet brake	
Combustion-engine	7.1	Engine manufacturer/type		BB-68G1TRC-06	BB-68G1TRC-06	BB-68G1TRC-06	TCD 3.6 L4	TCD 3.6 L4	TCD 3.6 L4	F3.8	F3.8	F3.8	YCA05115-S500	YCA05115-S500	YCA05115-S500	
		Engine standard		G 2	G 2	G 2	Stage V/T4f	Stage V/T4f	Stage V/T4f	Stage V/T4f	Stage V/T4f	Stage V/T4f	Stage V	Stage V	Stage V	
	7.2	Engine power according to DIN ISO 1585	kW	97.7	97.7	97.7	85	85	85	90	90	90	85	85	85	
	7.3	Rated speed	r/min	2200	2200	2200	2200	2200	2200	2200	2200	2200	2200	2200	2200	
7.4	No. of cylinders/displacement	[-]/[cm ³]	6/6494	6/6494	6/6494	4/3621	4/3621	4/3621	4/3759	4/3759	4/3759	4/4837	4/4837	4/4837		
Addition data	10.1	Operating pressure for attachments	bar	195	195	215	195	195	215	195	195	215	195	195	215	
	10.2	Oil volume for attachments	l/min	180	180	180	155	155	155	180	180	180	180	180	180	
	10.8	Towing coupling, type DIN 15170		Pin	Pin	Pin	Pin	Pin	Pin	Pin	Pin	Pin	Pin	Pin	Pin	

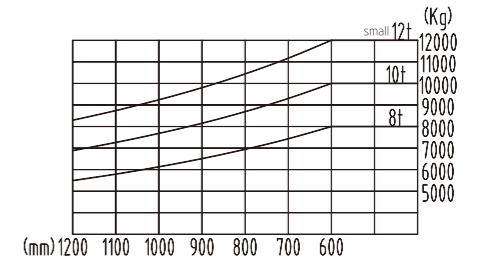
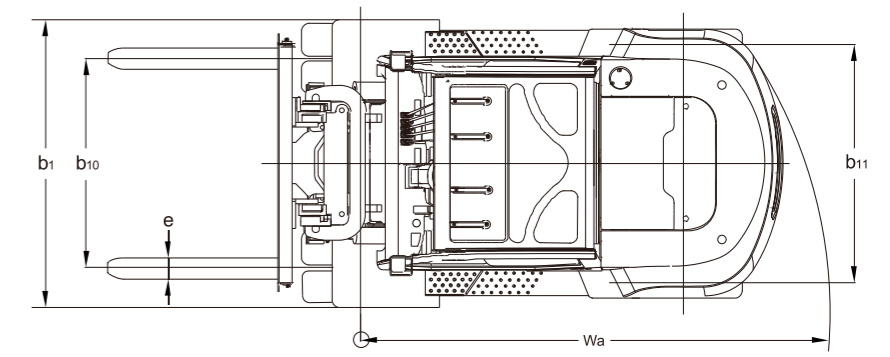
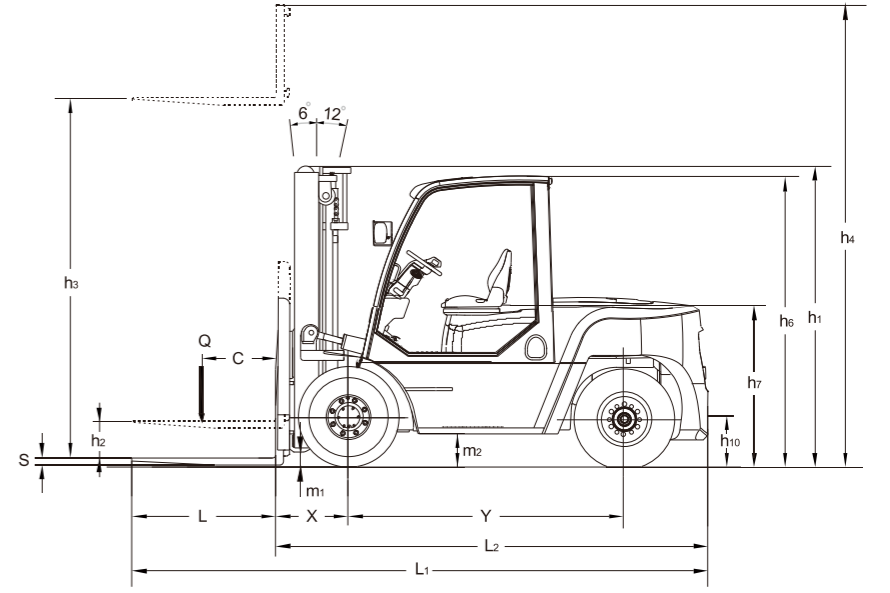

8.0-10t XF series mast: (pneumatic)

Type	Model	Max. fork height	Overall height			Free lift Without backrest	Load distance, centre of drive axle to fork	Tilt range	Load capacity		
			Lowered	Extended Without backrest	FWD/BWD				Load capacity at 600mm		
									Double tire		
mm	mm	mm	mm	kg	10t						
Wide view Duplex mast	X80M250	2500	2450	3715	200	714	6/12	8000	/		
	X80M270	2700	2550	3915	200	714	6/12	8000	/		
	X80M300	3000	2700	4215	200	714	6/12	8000	/		
	X80M330	3300	2850	4515	200	714	6/12	8000	/		
	X80M350	3500	2950	4715	200	714	6/12	8000	/		
	X80M360	3600	3000	4815	200	714	6/12	8000	/		
	X80M400	4000	3200	5215	200	714	6/12	8000	/		
	X80M430	4300	3400	5515	200	714	6/6	8000	/		
	X80M450	4500	3500	5715	200	714	6/6	8000	/		
	X80M480	4800	3650	6015	200	714	6/6	8000	/		
	X80M500	5000	3750	6215	200	714	6/6	8000	/		
	X80M550	5500	4050	6740	200	714	3/6	7400	/		
	X80M600	6000	4300	7240	200	714	3/6	7000	/		
	X80M650	6500	4600	7790	200	714	3/6	5800	/		
	X100M250	2500	2600	4055	200	726	6/12	/	10000		
	X100M270	2700	2700	4255	200	726	6/12	/	10000		
	X100M300	3000	2850	4555	200	726	6/12	/	10000		
	X100M330	3300	3000	4855	200	726	6/12	/	10000		
	X100M350	3500	3100	5055	200	726	6/12	/	10000		
	X100M360	3600	3150	5155	200	726	6/12	/	10000		
	X100M400	4000	3350	5555	200	726	6/12	/	10000		
	X100M430	4300	3550	5855	200	726	6/6	/	10000		
	X100M450	4500	3650	6055	200	726	6/6	/	10000		
	X100M480	4800	3800	6355	200	726	6/6	/	10000		
	X100M500	5000	3900	6555	200	726	6/6	/	10000		
	X100M550	5500	4200	7055	200	726	3/6	/	9000		
	X100M600	6000	4450	7555	200	726	3/6	/	8000		
	X100M650	6500	4750	8055	200	726	3/6	/	6700		
	Full free duplex mast	X80U230	2300	2350	3505	1145	719	6/12	8000	/	
		X80U250	2500	2450	3705	1245	719	6/12	8000	/	
		X80U270	2700	2550	3905	1345	719	6/12	8000	/	
		X80U300	3000	2700	4205	1495	719	6/12	8000	/	
		X80U330	3300	2850	4505	1645	719	6/12	8000	/	
		X80U360	3600	3000	4805	1795	719	6/12	8000	/	
		X80U400	4000	3200	5205	1995	719	6/12	8000	/	
		X100U230	2300	2500	3845	955	744	6/12	/	10000	
X100U250		2500	2600	4045	1055	744	6/12	/	10000		
X100U270		2700	2700	4245	1155	744	6/12	/	10000		
X100U300		3000	2850	4545	1305	744	6/12	/	10000		
X100U330		3300	3000	4845	1455	744	6/12	/	10000		
X100U360		3600	3150	5145	1605	744	6/12	/	10000		
X100U400		4000	3350	5545	1805	744	6/12	/	10000		
X80N450		4500	2750	5775	1485	759	6/6	7000	/		
X80N480		4800	2850	6075	1585	759	6/6	7000	/		
X80N500		5000	2950	6380	1600	759	6/6	8500	/		
Full free triplex mast		X80N550	5500	3100	6810	1800	759	3/6	6100	/	
	X80N600	6000	3250	7275	1985	759	3/6	5600	/		
	X80N650	6500	3530	7840	2200	759	3/6	5000	/		
	X80N700	7000	3700	8310	2400	759	3/6	4200	/		
	X100N450	4500	2850	6055	1305	794	6/6	/	8500		
	X100N480	4800	2950	6355	1405	794	6/6	/	8500		
	X100N500	5000	3050	6555	1505	794	6/6	/	8200		
	X100N550	5500	3200	7055	1655	794	3/6	/	7700		
	X100N600	6000	3350	7555	1805	794	3/6	/	7000		
	X100N650	6500	3630	8055	2085	794	3/6	/	6200		
	X100N700	7000	3800	8555	2255	794	3/6	/	5200		

With sidershifter minus 500Kg, with integral sidershifter minus 400kg.

12t XF series mast: (pneumatic)

Type	Model	Max. fork height	Overall height			Free lift Without backrest	Front overhang	Tilt range	Capacity		
			Lowered	Extended Without backrest	FWD/BWD				Load capacity 600mm		
									Double tire		
mm	mm	mm	mm	mm	mm	kg					
Wide view mast	XX120M270	2700	2850	4405	200	739	6/12	12000			
	XX120M300	3000	3000	4705	200	739	6/12	12000			
	XX120M330	3300	3150	5005	200	739	6/12	12000			
	XX120M360	3600	3300	5305	200	739	6/12	12000			
	XX120M400	4000	3500	5705	200	739	6/12	12000			
	XX120M430	4300	3700	6005	200	739	6/6	12000			
	XX120M450	4500	3800	6205	200	739	6/6	12000			
	XX120M480	4800	3950	6505	200	739	6/6	12000			
	XX120M500	5000	4050	6705	200	739	6/6	12000			
	XX120M550	5500	4350	7205	200	739	3/6	10500			
	XX120M600	6000	4600	7705	200	739	3/6	9000			
	XX120M650	6500	4900	8205	200	739	3/6	7500			
	Full free triplex mast	XX120N450	4500	3000	6205	1305	807	6/6	10200		
		XX120N480	4800	3100	6505	1405	807	6/6	10200		
		XX120N500	5000	3200	6705	1505	807	6/6	9800		
		XX120N550	5500	3350	7205	1655	807	3/6	9200		
		XX120N600	6000	3500	7705	1805	807	3/6	8000		
		XX120N650	6500	3780	8205	2085	807	3/6	7000		

Features

Truck	Standard	Options
Traction device	●	
Hand grip	●	
Standard seat	●	
Floating overhead guard	●	
Waterproof cover on the guard	●	
Back view mirror	●	
Pneumatic tyres	●	
Floating cabin		○
Cabin heater		○
Front window		○
Super elastic tyre		○
Non-mark tyre[white/green]		○
Suspension seat		○
Extinguisher		○
Special given color		○
Boot for tilt cylinder		○
Counter weight net		○
Seat sensor system		○
Hood lock (for W96 engine)		○
Toolbox		○
Steering		
Full hydraulic power steering	●	
Smaller diameter steering wheel	●	
Adjuster of steering wheel	●	
Shock absorber of steering axle	●	
Chassiss		
Skidproof pedal	●	
Rubber pedal	●	
Engine hood spring	●	
Hydraulic		
Dynamic load sending control valve	●	
Hydraulic oil filter	●	
Tilt cylinder self-lock valve	●	
Hydraulic oil dipstick	●	
Accumulator	●	
Hydraulic oil radiator	●	
Auxiliary hydraulic valve		○
Electro-hydraulic		○
Proportional control system		○
Power		
Big capacity aluminum radiator	●	
Whirlwind air cleaner	●	
Safety filter	●	
High-efficient intake muffler	●	
High-efficient exhaust muffler	●	
Middle-positioned exhaust system [W41]	●	
High-positioned exhaust system [W95/H16/H15]	●	
Upright exhaust system		○
Air pre-cleaner		○
Net cover of radiator		○
Spark arrester		○
Purified exhaust system		○
Fan protector		○
Transmission		
Suspension transmission	●	
Oil filter	●	
Dipstick	●	
Oil cooler	●	
Drum brake[8t W41/10t W41]	●	
Wet brake[W96/H16/H15/small 12t W41]	●	
Wet brake		○

Electronics	Standard	Options
High-efficient front lights	●	
High-efficient LED rear lights	●	
Service-free start battery	●	
Combination controller	●	
LCD display	●	
Neutual switch	●	
Hour meter	●	
Fuel gauge	●	
Water temperature gauge	●	
Pre-heat indicator	●	
Charging indicator	●	
Engine fuel pressure warning	●	
Oil temperature	●	
Horn	●	
Reversing buzzer	●	
Air-filter with jam sensor	●	
Emergency power off	●	
OBD		○
Front working light		○
Rear working light		○
Warning lamp		○
Mast		
Standard wide view duplex mast	●	
Standard forks	●	
Standard fork carriage	●	
Mast speed limiting valve	●	
Load safety valve	●	
Mast down buffer device	●	
Mast up buffer device	●	
Side roller	●	
Fork positioner	●	
Duplex wide view free-lift mast		○
Triplex wide view free-lift mast		○
Special forks		○
Wider fork carriage		○
Widerload back rest		○
Optional Attachments		
Paper roll clamp		○
Rotating bale clamp		○
Load stabilizer		○
Multi-drum clamp		○
Bale clamp		○
Drum clamp		○
Dumping clamp		○
Crane arm		○
String Pole		○
Sidershifter		○
Rotating forks		○
Fork extensiorer		○
Load release device		○
Carton clamp		○
Push-pull device		○
Bucket		○
Hook		○
Lengthened fork		○
Control		
Power steering	●	
Suspension pedal	●	
Integrated combination switch	●	
Parking brake	●	